

BIRD-X

Humane Bird Control Solutions



BIRD-X CATALOG VERSION 2

Bird & Wildlife Control Products



TABLE OF CONTENTS

4.....Ultrasonic Deterrents

6.....Ultrasonic/Sonic Deterrents

7.....Sonic Deterrents

12.....Visual Deterrents

15.....Roost Inhibitors

21.....Liquid & Gel Aversions

22.....Electronic Repellers

24.....Bird-X Retail Products



FOLLOW US ON SOCIAL MEDIA



BIRD-X

Humane Bird Control Solutions



Humane & Eco-friendly Solutions
Experienced Sales Consultants
Unmatched Quality
Worldwide Distribution
Outstanding Customer Service

Bird-X is the leading brand of *humane* and *eco-friendly* bird and pest control solutions worldwide — protecting human health, wildlife and the environment in which we all live.

Established in 1964, our Chicago-based company manufactures a complete line of unique pest control products with an unmatched focus on quality, efficacy and customer service.

Bird-X works closely with professional installers and pest management professionals on projects of all sizes.

HIGH PROFILE CLIENTS TRUST BIRD-X

Bird-X customers include:

- All Fortune 1000 companies
- Every major municipality
- All branches of the U.S. Military
- Major institutions nationwide
- Exports to over 160 countries



 (+1) 800-662-5021  (+1) 312-226-2473  solutions@bird-x.com  www.bird-x.com

QUADBLASTER QB-4

INDOOR ULTRASONIC BIRD DETERRENT + OPTIONAL STROBE LIGHT

The QuadBlaster QB-4 is our best-selling ultrasonic bird control system for indoor applications. The system is composed of 4 built in speakers and solid steel construction with the option to add a flashing strobe light for a multisensory attack that startles pest birds. Ultrasonic technology is silent to humans but irritating to pests. The QuadBlaster emits ultrasonic sounds specifically designed to disorient, intimidate, and irritate pest birds, deterring them out of the treated area. When birds are exposed to these unwelcoming sound waves, they are driven from the treated area and forced to find more accommodating areas to gather.

Pests: birds (pigeons, sparrows, starlings, swallows), bats, rodents

Applications: hangars, warehouses, factories, tunnels, loading docks, railroad sidings, breezeways, boat houses, underpasses, storage sheds, barns, sports arenas, convention centers, parking garages, car washes and other enclosed or semi-enclosed areas



Specifications

Coverage	up to 6,500 square feet
Power Requirements	12 VDC from 115v AC/60 Hz or 220v AC/50 Hz
Power Consumption	<10 watts
Dimensions	QB4 - 12" x 12" x 4"; strobe 6" x 4" x 4"
Weight	10.2 lbs
Sound Pressure	85-90 dB at 1 meter at 20 kHz (each speaker)
Frequency	Range 20-30 kHz
Strobe Flash Rate	60 triple pulse flashes per minute
Compliance	Supply power source is UL and CE listed. EPA Est. 075130-OR-001
SKU	QB4 (without strobe) or QB4+S (with strobe)
Origin	Assembled in the USA

ULTRASON X

ULTRASONIC BIRD DETERRENT SPEAKERS WITH SEPARATE CONTROL BOX

The Ultrason X is the world's first ultrasonic repeller specifically designed for year-round use in semi-enclosed areas and outdoors. The unit operates by creating ultrasonic sound waves that are above the range of most humans' hearing, effectively deterring birds while maintaining a comfortable environment for people. The Ultrason X is fully programmable and weather resistant. The convenient and flexible coverage makes it perfect for small residential spaces like balconies or patios and large commercial spaces like parking lots or retail stores.

Pests: birds (pigeons, sparrows, starlings, crows, blackbirds, grackles, seagulls, swallows), bats, rodents

Applications: Gas stations, parking lots, hotels, restaurants, balconies, patios, manufacturing or warehouse facilities, airports



Specifications

Coverage	up to 3,600 square feet
Power Requirements	110vAC (220vAC available)
Dimensions	Control Unit 9" x 9" x 5", Speakers 4" x 4" x 6"
Weight	15 lbs.
Speakers	8 ohms, 30 watts
Sound Pressure	95-102 dB (each speaker) at 1 meter
Frequency	15-25 KHz
Compliance	Supply power source is UL and CE listed. EPA Est. 075130-OR-001
SKU	USX
Origin	Assembled in the USA

BROADBAND PRO

COMBINES SONIC & ULTRASONIC TECHNOLOGY

The BroadBand PRO 4-speaker system is our only system that simultaneously emits sonic and ultrasonic sounds to confuse, disorient and intimidate pest birds, keeping them away. Each speaker includes 100 ft. of wire for more coverage. Ultrasonic sounds are inaudible to humans but highly irritating to birds and other pests. Sonic sounds include an unrelenting combination of species-specific distress calls, danger alerts and predator calls that condition pest birds to stay away. The combination of sonic and ultrasonic sounds make the area seem threatening to pest birds and will deter them from the treated area. The BroadBand PRO is fully programmable and users are able to control volume, sound delays, and day/night operation.

Pests: birds (pigeons, crows, blackbirds, grackles, sparrows, seagulls, starlings, swallows), bats, rodents

Applications: warehouses, manufacturing facilities, parking lots, garages, sheds, storage buildings, waterfront property, docks



Specifications

Coverage	Ultrasonic: Up to 900 sq. ft. per speaker (3,600 sq. ft. total), Sonic: Up to 6 acres
Power Requirements	110vAC (220vAC available)
Dimensions	Control Unit 9" x 9" x 5", Speakers 4" x 4" x 6"
Weight	10 lbs
Speakers	8 ohms, 30 watts
Sound Pressure	Ultrasonic sounds 95-102 dB (each speaker) at 1 meter Sonic 105-110 dB (each speaker) at 1 meter
Frequency	Ultrasonic 15-25 KHz, Sonic 3-5 KHz
Compliance	Supply power source is UL and CE listed. EPA Est. 075130-OR-001.
SKU	BB-PRO-B
Origin	Assembled in the USA

BIRDXPPELLER® PRO

SINGLE SPEAKER SONIC BIRD DETERRENT

The BirdXPeller® PRO gets rid of birds by emitting a variety of naturally recorded distress calls and predator calls that frighten and disorient pest birds. The authentic calls warn birds of an emergency and create a “danger zone,” deterring them from the area. The weather-resistant system is completely programmable and utilizes real sounds with clear and high-definition playback. The BirdXPeller® PRO is a safe and humane solution to protect your property from bird infestation. With three versions to choose from, you can tailor your bird control to work for you.

Version 1: Pigeons, starlings, sparrows, gulls

Version 2: Crows, ravens, blackbirds, grackles, cormorants

Version WP (Woodpecker PRO): Woodpeckers, sparrows

Applications: outdoor areas, private homes, parks, open lots, canopies, awnings, eaves, rafters, ceilings, entrances, warehouses, hangars, garages, barns, sheds, rooftops, parking lots, fields, buildings



Specifications

Coverage	up to 1 acre
Power Requirements	110 or 220vAC or 12vDC (110vAC adapter included; 12v battery not included, alligator clip required for battery)
Dimensions	6" x 9" x 4"
Weight	3 lbs.
Sound Pressure	105 - 110 dB at 1 meter
Frequency	3 - 5 kHz
Compliance	Supply power source is UL and CE listed. EPA Est. 075310-OR-001.
SKU	BXP-PRO 1, BXP-PRO 2, BXP-PRO WP
Origin	Assembled in the USA

SUPER BIRDXPPELLER® PRO

4-SPEAKER SONIC BIRD REPELLER

With up to six times the coverage as the BirdXPeller® PRO, the Super BirdXPeller® PRO comes with four speakers and enough wire to place and position in any environment. It gets rid of birds by emitting a variety of naturally recorded distress calls and predator calls that frighten and disorient pest birds. The authentic calls warn birds of an emergency and create a “danger zone,” deterring them from the area. The weather-resistant system is completely programmable and utilizes real sounds with clear and high-definition playback. The Super BirdXPeller® PRO is a safe and humane solution to protect your property from bird infestation. With three versions to choose from, you can tailor your bird control to work for you.

Version 1: Pigeons, starlings, sparrows, gulls

Version 2: Crows, ravens, blackbirds, grackles, cormorants

Version WP (Woodpecker PRO): Woodpeckers, sparrows

Applications: outdoor areas, parks, open lots, entrances, warehouses, hangars, garages, barns, sheds, rooftops, parking lots, airfields, fields, landfills, large buildings



Specifications

Coverage	Up to 6 acres
Power Requirements	110 or 220vAC or 12vDC (110vAC adapter included; 12v battery not included, alligator clip required for battery)
Dimensions	Control Unit 9" x 9" x 5.25"; Speakers 4" x 4" x 6"
Weight	10 lbs
Speakers	8 ohms, 30 watts
Sound Pressure	105 - 110 dB at 1 meter (each speaker)
Frequency	3 - 5 kHz
Compliance	Supply power source is UL and CE listed. EPA Est. 075310-OR-001.
SKU	BB-PRO
Origin	Assembled in the USA

GOOSEBUSTER® PRO

DETER GEESE WITH NATURALLY RECORDED SOUNDS

The GooseBuster® PRO is a one-of-a-kind system that was developed using decades of scientific research involving the behaviors and vocal communications of Canada geese. The scientifically proven GooseBuster® broadcasts authentic Canada goose sounds through four state-of-the-art speakers; the alert call lets geese know there is potential for trouble and the alarm call signifies immediate danger. The GooseBuster® is programmed to constantly change duration and sound combinations, making geese feel under threat and evacuate the area without identifying the source.

A single speaker version is ideal for smaller applications.

Pests: Geese, ducks

Applications: golf courses, ponds, parks, schools, hospital grounds, resorts, cemeteries, condominium complexes, large estates, other areas with large congregations of geese



4-speaker



Single speaker

Specifications

Coverage	up to 7 acres (GooseBuster®), up to 1.5 acres (GooseBuster® PRO)
Power Requirements	1 amp 110 or 220vAC adaptor, or 12vDC
Dimensions	Control Unit 9" x 9" x 5.25"; Four speakers 10" x 8" x 5" (GooseBuster®) Control Unit 6" x 6" x 3.5", Speaker 5.5" x 5.5" x 5" (GooseBuster® PRO)
Weight	16 lbs. (GooseBuster®), 4 lbs. (GooseBuster® PRO)
Speakers	8 ohms, 30 watts
Frequency	500 – 1,500 Hz
Compliance	Supply power source is UL and CE listed. EPA Est. 075310-OR-001.
SKU	GB, GB-1
Origin	Assembled in the USA

MEGA BLASTER PRO

20-SPEAKER EFFECTIVE LARGE AREA BIRD CONTROL

Our most powerful unit, the Mega Blaster PRO, is a heavy-duty, professional grade bird deterrent. The unit is designed for large area bird control and is trusted by airports worldwide. The system features two high-output amplifiers that drive our specially designed 20-speaker tower. The intense sound output covers up to 30 acres (12 hectares). The Mega Blaster PRO features solid-state electronics mounted inside a NEMA-type control box, suitable for virtually any large outdoor application. The unit comes pre-recorded in four different configurations for the most common bird infestations.

Pests: gulls, marine birds, crows, ravens, starlings, blackbirds, grackles, woodpeckers, ring-billed gull, herring gull, california gull, black-headed gull, glaucous-winged gull, double crested cormorant

Applications: any multi-acre facility including landfills, chemical plants, airports, fish farms, beaches, lakes, parks, large estates



Specifications

Coverage	Up to 25 acres (10 hectares)
Included	Generating unit with two built-in high-output amplifiers, 20-speaker tower with audio cables, 40-watt solar panel, battery clips, all mounting hardware
Power Requirements	12VDC (3 AMPS) via Solar Panel and Battery
Dimensions	Unit: 22" x 18" x 13", Solar Panel: 24" x 25" 5"
Weight	Unit: 20 lbs, Solar Panel: 14 lbs
Sound Pressure	Up to 125 dB
Frequency	2,000 - 10,000 Hz
Compliance	Supply power source is UL and CE listed. EPA Est. 075130-OR-001
SKU	MEGA, MEGA-AG (agriculture), MEGA-CROW (crow/raven), MEGA-WP (woodpecker), MEGA-MAR (gull/marine birds)
Origin	Assembled in the USA

⚠ NOTICE: This unit is capable of sound output up to 125 decibels. Hearing protection is recommended.

CRITTER BLASTER PRO®

OUR MOST AGGRESSIVE SONIC ANIMAL DETERRENT

Eliminate pest problems with our most aggressive sonic product. The Critter Blaster PRO comes with a weatherproof control box plus four separate directional speakers, each with 100 feet of wire. The system is designed for large, remote outdoor areas and uses digitally recorded, customizable harassment sounds to repel ALL animals.

With a range of up to 6 acres, the aggressive digitally recorded sounds of the Critter Blaster PRO will irritate and alarm ALL species without traps or chemicals. Four powerful speakers can be mounted anywhere to emit a series of harassment sounds that drive animals away and train them to stay away. The Critter Blaster PRO is fully programmable with eight digitally recorded sounds that can be played at various intervals. The weather-resistant and flexible coverage makes it perfect for large outdoor areas.

Pests: All

Applications: airports, farms, fields, landfills, large buildings and areas



Specifications

Coverage	up to 6 acres
Included	Control unit, 4 speakers with cords, AC adapter with cord, DC battery cables, complete instructions
Power Requirements	1 amp, 110 or 220vAC adapter or 12vDC
Dimensions	Control Unit 9" x 9" x 5.25", Speakers 4" x 4" x 6"
Weight	10 lbs.
Speakers	8 ohms, 30 watts
Frequency	2 - 10 kHz
Compliance	Supply Power Source is UL and CE listing. EPA Est. 075310-OR-001.
SKU	CB-PRO
Origin	Assembled in the USA

BIRD DETERRENT LASERS

CLASS 3R "FAT BEAM" LASER FOR INDOOR/OUTDOOR USE

Laser deterrent devices flash the area and the pest with disorienting laser light and they quickly learn that this area is unwelcoming. Since the deterrent works by bothering the pests' eyesight, it is reliably effective against a huge variety of pest animals. Bird-X Laser devices use "Fat Beam" technology to ensure our units are safe to use near humans while being strong enough to deter the pests.



Handheld Specifications

Classification	Class 2M
Laser Beam Color	Green
Service Life Laser Source	5,000 h
Power Source	2x CR123battery
Power Input	3.6 VDC -9 VDC
Energy Consumption	2 W
Dimensions	7.7" x 1.0" x 1.0"
Weight	6.3 oz
Operating Temperature	23 °F to 113 °F (-5 °C to 45 °C)
Storage Temperature	14 °F to 122 °F (-10 °C to 50 °C)
SKU	BX-LASER-H-50



Indoor Specifications

Laser Power	Red: 650nm100mW; Green: 532nm50mW
Unit Power	4.9mW RED+4.9mW GREEN
Power Consumption	50 Watt
Laser Color	Red + green
Net Weight	3.3 lbs
Power	AC100-240V,50-60Hz
Electric Current	100mA
Classification	CLASS 3R
Size	7.3" x 5.8" x 2.75"
Fuse	2A
Housing	Cast aluminum
Beam Divergence	60°
Operating Temp.	32°F - 104°F (0°C - 40°C)
Safe Temp. for Use	32°F - 95°F (0°C - 35°C)
Origin	Made in China
SKU	BX-LASER-IN

Outdoor Specifications

Laser Power	Red: 650nm100mW; Green: 532nm50mW
Unit Power	1mW RED+1mW GREEN
Laser Color	Red + Green
Net Weight	3.3 lbs
Power	AC100-240V,50-60Hz
Electric Current	100mA
Classification	Class 2
Size	7.3" x 5.8" x 2.75"
Housing	Cast aluminum
Beam Divergence	60°
Operating Temp.	-4°F - 104°F (-20°C - 40°C)
Safe Temp. for Use	14°F - 95°F (-10°C - 35°C)
Waterproof Level	IP65
Origin	Made in China
SKU	BX-LASER-OUT

PREDATOR DECOYS

INTIMIDATE PESTS WITH REALISTIC PREDATOR DECOYS



3D COYOTE REPLICA

This menacing coyote replica frightens geese, birds and other small pests away from open outdoor areas. The 3D structure and lifelike presence is highlighted by its moving fur tail.

COYOTE-3D



GATOR GUARD®

The Gator Guard® floats and bobs on top of water as mirrored eyes catch the sun with 3-dimensional, 360° visibility; birds think they are being followed. Effectively scares off geese, herons, and other waterbirds.

GG



PROWLER OWL

Scare away birds and small pests with this predator replica a Great Horned Owl. Install the Prowler Owl decoy in any open outdoor area where pest birds or small critters are a problem. The owl's wings move and flap in the breeze making it appear even more lifelike to pests.

OWL



TERROR EYES®

Terror Eyes® bright colors and fierce features mimic natural predators. Holographic eyes create the illusion of a predator following pest birds to attack, while moving organically with the wind. It is easy to install and requires little to no maintenance.

T-EYES+



SCARE EYES®

Scare-Eye® Balloons keep birds away with simple vinyl ball visual deterrents that move with the wind and intimidate pest birds within visible range. The set includes three balloons – black, white, and yellow. Includes strings, mylar eyes, and mylar tails for each balloon bird scare.

SE-PACK

OTHER VISUAL DETERRENENTS

SCARE AND IRRITATE PEST BIRDS

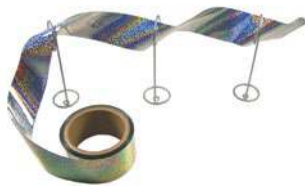

IRRI-TAPE®

Irrri-Tape® is a multi-sensory attack scares birds away from the treated area. Sunlight reflects off the material, disorienting and irritating pest birds, and a sharp metallic clacking sound is made when the tape flaps in the wind. Irrri-Tape® is easy to install, and a very simple and effective solution. Bird tape is often used in farms, vineyards, gardens and other agricultural applications. Available in a roll of 100 ft. or 500 ft.

TAPE-100

TAPE-500



BIRD DEFLECTOR

Uses sunlight and wind to create flashing lights during daylight hours to deter seagulls and other migratory birds. Can be screwed or glued into place. Equipped with adjustable angle arm for multiple positions.

BD



BIRD STROBE LIGHT

The Bird Strobe Light is disorienting and intolerable to pigeons and other pest birds. With a range of up to 10,000 square feet, the Bird Strobe Light uses multicolor stroboscopic light to drive away pest birds. The intimidating and intense red, white, and blue light flashes 75 times per minute at 1 million candlepower. This makes the indoor space you are protecting completely undesirable to birds, while remaining noise free for humans. International voltage options available upon request. Made in the USA.

BSL

AVISHOCK™ TRACK

LOW-PROFILE ELECTRIFIED TRACK THAT CONFORMS TO ANY SURFACE

Condition birds to stay away with low-profile electrified track that conforms to any surface. The intermittent shock is memorable but does not hurt the birds; it simply conditions them to stay away, long-term.

Avishock conforms easily to most building structures and shapes. The special design utilizes snap connectors, reducing labor for an easy install. Avishock is low-profile (just 0.3" high) and available in four colors to match the structure. Shock Track is virtually invisible from a distance. It cannot be seen looking up from below.

Avishock is made from UV-stabilized PVC and high-grade metal conducting channels. The reduced-resistance copper conduction strips are protected from weather and dirt by a conductive plastic cover.

BLACK
SHK102



STONE
SHK101



GREY
SHK105



65 FT. ROLLS



SOLAR CHARGER

300-2,500 ft. of track

Solar-powered charger with weather resistant case.

SHK-C-SOL



110V AC CHARGER

300-1,000 ft. of track

SHK-C-110



FEMALE SPADE CONNECTORS (X100)
SHK023-100



STRAIGHT CONNECTOR (X20)
SHK121



MALE SPADE CONNECTORS (X100)
SHK029-100



CORNER CONNECTOR (X20)
SHK122



CONNECTOR RING TERMINAL (X10)
SHK024



JUMPER (X20)
SHK123



WANT TO LEARN MORE ABOUT SHOCK TRACK?

Refer to pages 9-10 of the Bird-X Installer Catalog for our full selection of Shock Track parts and hardware. Call our team at 312-226-2473 for more information.

AVIANGLE

LEDGE EXCLUSION DEVICE PREVENTS BIRDS FROM LANDING

AviAngle™ is a bird exclusion device that excludes all pest birds and wildlife from ledge-based areas. Made of rigid PVC with UV inhibitors, AviAngle™ is resistant to virtually all weather conditions and harsh environments when installed according to manufacturer instructions. The smooth surface of the UV-protected PVC material turns any surface with a 90° angle into a 45° slope that prohibits birds and from landing and getting a stable foothold.

AviAngle™ can be installed using Bird-X Special Adhesive, wood screws, nails or clamps, depending on the surface area and the application. AviAngle™ Base Unit will cover approximately 6" of ledge depth, comes in four (4') linear foot sections and is packaged in 12 sections per box for a total of forty-eight (48') linear feet per box.



AVI-ANGLE

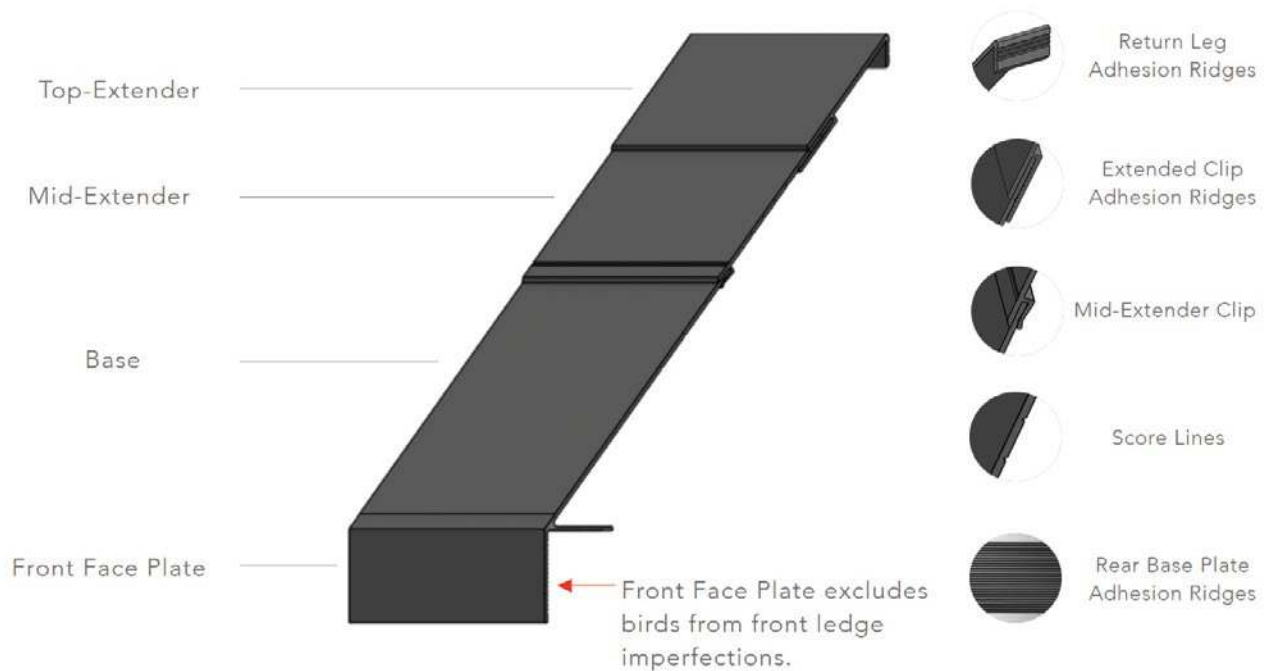

SOLAR MESH KIT

PROTECT SOLAR PANELS FROM COSTLY PEST DAMAGE

This system securely protects panels from pest birds and rodents without damaging or voiding the panel warranty. The mesh is made of stainless steel welded into half inch squares and coated in thick protective PVC coating that is resistant to UV degradation and chemical corrosion. Bespoke panel clips are made from UV protected nylon. The Solar Mesh Kit can be mounted to any solar panel with a bracket depth of greater than 30 mm.



SIMPLE TO INSTALL
Watch our installation demo



SOLAR KIT

Includes 100 ft. of mesh and 100 fastening clips.

SOLAR KIT

MESH ONLY

Material: 302 stainless steel

Length: 100 ft.

Wire gauge: 0.7 mm

Width: 8"

PVC thickness: 0.3 mm

Grid: 1/2" squares

SOLAR MESH

FASTENING CLIPS ONLY

Material: UV protected nylon

Length: 123 mm

Clip depth: 32 mm

Width: 10 mm

Count: 100 pieces

SOLAR CLIP



STAINLESS STEEL BIRD SPIKES

PREVENT BIRDS FROM LANDING AND ROOSTING ON SURFACES

Stainless Steel Bird Spikes have been the industry standard for over 20 years. Bird spikes are a 100% effective, maintenance-free and permanent solution to pest bird infestation. The spikes are not harmful – just irritating, intimidating, and uninviting, making it difficult, if not impossible, to land on the treated surface. The heavy duty stainless steel won't corrode and the UV-treated flexible polycarbonate base allows for installation on curved surfaces. Spikes come in a variety of sizes, heights and widths, and in lengths of up to 100 feet.

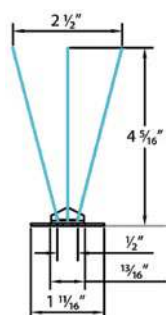

SLIM

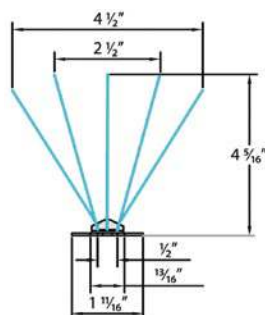

STANDARD

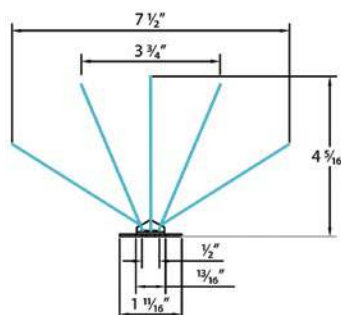

EXTRA WIDE

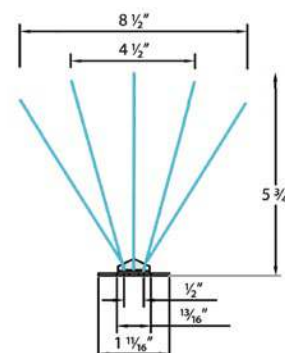

EXTRA TALL

Coverage	Each section of spikes covers 2 linear feet
Base Width	0.8" base width
Height	Highest point 4.3" (5.75" for Extra-Tall)
Spread	7.5" (Extra-Wide), 8.5" (Extra-Tall), 4.5" (Regular), 2.5" (Slim)
Net Weight	10 lbs. per 100' (Slim), 14 lbs. per 100' (Standard), 15 lbs. per 100' (Extra Wide), 19 lbs. per 98' (Extra Tall)
Packaging	Kits of 10', 24', 50' and 100'
Material	Polycarbonate base with UV inhibitors and high grade stainless steel rods
SKU	Slim: SLS-(length), Standard: STS-(length), Extra-Wide: EWS-(length), Extra-Tall: ETS-(length),

PLASTIC BIRD SPIKES

DURABLE, TRANSPARENT POLYCARBONATE NEEDLE STRIPS

Bird spikes function as a 'keep-out' sign for birds. Dense bird spikes branch out from the vertical shafts to offer impenetrable coverage. The flexibility of bird spikes allow mounting on flat or curved surfaces and are easy to install. Stackable 12" sections make it easy to carry a quantity of bird spikes and help minimize waste.

Bird-X Plastic Bird Spikes come in two widths: narrow and regular, and in lengths ranging from 10 feet to 100 feet. No matter the location, you can stop birds from perching with this effective physical barrier.

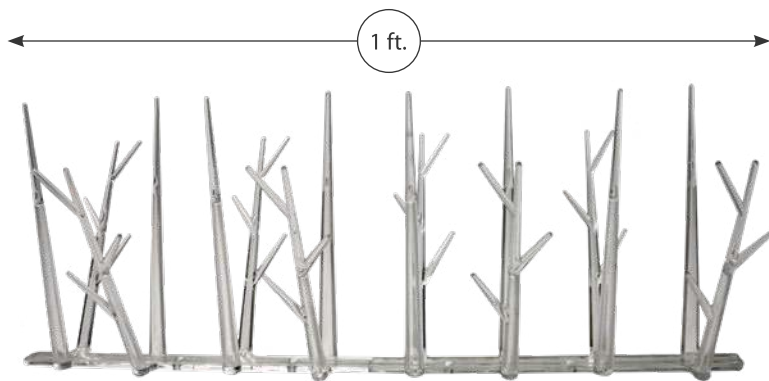

Coverage	Each section of spikes covers 1 linear foot
Base Width	0.5" (Narrow), 1" (Standard)
Height	Highest point 4.75"
Spread	2.5" (Narrow), 6.5" (Standard)
Net Weight	9 lbs. per 100' (Narrow), 24lbs. per 100' (Standard)
Packaging	Kits of 10', 25', 50' and 100'
Material	Polycarbonate with UV Inhibitors
SKU	Narrow: SP-(length)-N, Standard: SP-(length)
Origin	Made in the USA

BIRD & BAT CONTROL NETTING

CHOOSE FROM STANDARD, STRUCTURAL AND PREMIUM GRADE

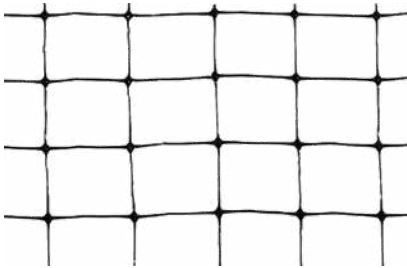

STANDARD NETTING

The 3/4" Standard Polypropylene Net blocks birds, bats and other wildlife from entering a treated area. Seal pests out of desired areas, preventing roosting, nesting, feeding, and damage. One-year warranty against material defects and workmanship. Made in the USA.

NET-STD-100-14

NET-STD-200-14

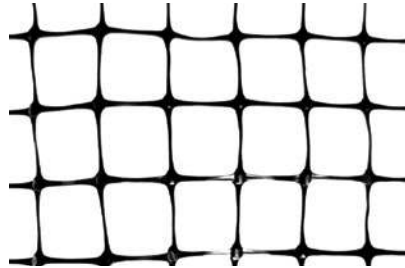

STRUCTURAL NETTING

The 1/2" Heavy Duty Polypropylene Net physically blocks pests from entering, roosting, nesting, feeding, and causing damage for up to 5 years. Five-year warranty against material defects and workmanship. Made in the USA.

NET-STR-100

NET-STR-200



PREMIUM NETTING

The highest grade premium netting, Polyethylene Netting blocks birds, bats and other pests from entering. Premium netting is strong enough to stand up to large animals including deer, coyotes, and dogs. Ideal for commercial settings. 10-year warranty against material defects and workmanship. Available in Black or Stone.

3/4" BLACK

NET-PE-25-25

NET-PE-25-50

NET-PE-50-50

NET-PE-50-100

NET-PE-100-100

3/4" STONE

NET-PE-25-25-STONE

NET-PE-25-50-STONE

NET-PE-50-50-STONE

NET-PE-50-100-STONE

1 1/8" BLACK

NET-PE-25-25-1

NET-PE-25-50-1

NET-PE-50-50-1

NET-PE-50-100-1

2" BLACK

NET-PE-25-25-2

NET-PE-25-50-2

NET-PE-50-50-2

NET-PE-50-100-2

NET-PE-100-100-2



CUSTOM SIZING AVAILABLE



MOUNTING CLIPS

Mounting Clips are the easy way to install Bird-X netting. Effective, durable, and secure, these heavy-duty clips snap onto netting edges and hold securely. Installs easily with screws, nails, adhesive, cable, or velcro.

MTG-CASE

LIQUID & GEL AVERSIONS

DETER BIRDS USING SENSORY EXPERIENCES



BIRD PROOF GEL

Bird Proof Gel creates a tacky texture on surfaces that is uncomfortable to birds and deters them from the surface. Discreet and low-profile, perfect for ledges, window sills, gutters and beams. Made in the USA.

BP-CART



4 THE BIRDS

Keep pest birds from roosting or landing on any surface. This sticky, transparent liquid remains tacky after application has set. Spray product on trees, shrubs, beams, and more for quick and lasting bird repellent. Made in the USA.

BP-LIQ-1



BIRD STOP

Bird Stop is a biodegradable food-grade taste aversion liquid. The product creates an invisible barrier that irritates birds' trigeminal systems (similar to our sense of smell), for a harmless but potent effect. Directly apply to surfaces by painting or spraying liquid to repel birds from feeding, loitering and landing. Proudly made in the USA.

BS-GAL



SAFETY SOLVENT CLEANER

Safely cleans and removes Bird Proof Liquid and/or Gel from surfaces. Made in the USA.

BPS-GAL



Photo credit: Mabel Amber

ELECTRONIC REPELLERS

ELECTRONIC REPELLERS FOR COMMON HOUSEHOLD PESTS



TRANSONIC PRO

Heavy-duty, commercial grade electronic pest repeller. Versatile professional-grade deterrent features three different sound modes and volumes. Effectively repels insects, small rodents, bats, birds, lizards, snakes. Covers up to 3,500 sq. ft. For indoor or protected outdoor use.

TX-PRO



TRANSONIC BUGCHASER

Electronic insect repeller. Versatile professional-grade deterrent features three different sound modes and volumes. Effectively repels cockroaches, ants, spiders, flies, mosquitos and other insects. Covers up to 1,500 sq. ft. For indoor or protected outdoor use.

TX-BUG



TRANSONIC MOLE

Multi-sensory solar-powered repeller for burrowing animals. Transonic Mole electronically repels moles, voles, gophers and more by combining ultrasound, vibration, and flashing light. Covers up to 3,500 sq. ft. For outdoor use.

TX-MOLE



PEST-X

Easy to use plug-in pest control device. Covers average size rooms; use more units for large spaces or in rooms with a lot of furniture, as the frequencies will not penetrate solid objects or walls. For indoor use.

PX-110

PX-220

PX-240



ELECTRONIC REPELLERS

GUARD YOUR HOME AND YARD FROM UNWANTED PESTS



YARD GARD

The Yard Gard™ is an ultrasonic deterrent that effectively repels deer, raccoons, skunks, and other small animals. Adjustable frequency of 15-25KHz makes it silent to most humans. The Yard Gard has a motion-sensor setting along with the standard, continuous setting. Device is weather-resistant and fully programmable. Covers up to 4,000 sq. ft.

YG



SOLAR YARD GARD

The solar-powered version of the Yard Gard. The Solar Yard Gard comes equipped with an optional flashing LED light that startles pests. Device comes with a USB charging cable. Solar Yard Gard has a motion-sensor setting along with the standard, continuous setting. Covers up to 3,000 sq. ft.

YG-SOLAR



BALCONY GARD

The Balcony Gard is an ultrasonic deterrent that effectively repels birds. Adjustable frequency of 15-25KHz makes it silent to most humans. The Balcony Gard has a motion-sensor setting along with the standard, continuous setting. Device is weather-resistant and fully programmable. Designed for residential use. Covers up to 900 sq. ft.

BG



DEER GARD

The Deer Gard is an ultrasonic deterrent that effectively repels deer. Adjustable frequency of 15-25KHz makes it silent to most humans. The Deer Gard has a motion-sensor setting along with the standard, continuous setting. Device is weather-resistant and fully programmable. Covers up to 4,000 sq. ft.

DG



SONGBIRD MAGNET

The Songbird Magnet is a one-of-a-kind sonic device that attracts songbirds to your yard using authentic bird calls. The device has two settings that draw Purple Martins or Favorite Songbirds (Baltimore Oriole, House Finch, Indigo Bunting, American Goldfinch, House Wren and Northern Bluebirds). Covers up to 6,000 sq. ft.

SBM

BIRD-X RETAIL PRODUCTS



Plastic Bird Spikes + Adhesive
Narrow: 2.25" spread
10 ft. retail kit
SP-10-NR



Stainless Steel Bird Spikes
Regular: 5" spread
10 ft. retail kit
STS-10-R



Irri-Tape
Bird repellent tape.
25 ft. roll.
TAPE-25



Bird Proof Gel
10 oz. tube
BP-CART



Balcony Gard
Electronic pest repeller for birds
BG



Yard Gard
Electronic pest repeller
YG



Solar Yard Gard
Electronic pest repeller
YG-SOLAR



Deer Gard
Electronic pest repeller for deer
DG



Songbird Magnet
Attracts songbirds
SBM



Transonic PRO
Heavy-duty commercial grade electronic pest repeller
TX-PRO



Transonic Bugchaser
Electronic pest repeller
TX-BUG



Pest-X
Electronic ultrasonic repeller for bugs and small rodents
PX-110 **PX-220**
PX-110-2 **PX-220-2**



3D Coyote
Predator decoy
COYOTE-3D



Gator Guard
Predator decoy
GG



Prowler Owl
Predator Decoy
OWL



Falcon
Predator decoy
FALCON



Scare Eye Balloon (1)
Visual scare. Yellow.
SE-Y



Scare Eye Balloons (3)
Visual scare. Pack of three.
SE-PACK



